



*AT-VLS-102DE*

Manual

**ATAL B.V.**  
Ampèrestraat 35-37  
NL-1446 TR PURMEREND

Postbus 783  
NL-1440 AT PURMEREND

T (+31) 0299 630 610  
F (+31) 0299 630 611

E [info@atal.nl](mailto:info@atal.nl)  
I [www.atal.nl](http://www.atal.nl)

## PRODUCT DESCRIPTION

**Programmable regulators** with Ethernet connection are designed to measure temperature and relative humidity of air, to measure concentration of CO<sub>2</sub> in the air, to signal alarms and control of external devices. Regulators can be used in a chemically non-aggressive environment.

**The CO<sub>2</sub> concentration** is measured using the maintenance free sensor. The unique patented auto-calibration procedure compensates aging of the sensing element and guarantees outstanding high reliability and long-term stability.

**The function of two output relays** can be set using the device keyboard or from computer. It is possible to assign any input or computed value (dew point temperature, absolute humidity, specific humidity mixing ratio and specific enthalpy) to each relay. Setting of delay, hysteresis, audible alarm is enabled for each relay and it is possible to control output relay status via Ethernet too. The instrument may send a warning message if the measured value goes out of adjusted limits. Devices are equipped with four button keyboard and two-line LCD display. The visual indication of the concentration of CO<sub>2</sub> is provided by three LEDs to the left side of the display.

**The supported Ethernet communication formats:** www pages with user-design possibility, Modbus TCP protocol, SNMPv1 protocol and SOAP. For setting of all parameters you can use *TSensor* software.

type *	measured values	version	mounting
<b>AT-VLS-104DE</b>	CO <sub>2</sub>	probe on cable	wall
<b>AT-VLS-101DE</b>	CO <sub>2</sub>	ambient air	wall
<b>AT-VLS-102DE</b>	T + RH + CO <sub>2</sub> + CV	ambient air	wall
<b>AT-VLS-106DE</b>	T + RH + CO <sub>2</sub> + CV	probes on cable	wall

\* T...temperature, RH...relative humidity, CO<sub>2</sub>...concentration CO<sub>2</sub> in air, CV...computed values

## INSTALLATION , OPERATION AND CONFIGURATION

The mounting holes and connection terminals are accessible after unscrewing the four screws in the corners of regulator and removing the lid. Devices have to be mounted on a flat surface to prevent deformation. For output relays connection choose cables with external diameter 4 to 6.5mm and wire cross-section 0.14 to 1.5mm<sup>2</sup>. Do not forget to insert attached plugs into unused cable glands. Unpack the external CO<sub>2</sub> probe and connect it to the regulator. Pay attention to mounting the device and probes, because incorrect choice of working position or place of measuring could adversely affect accuracy and long-term stability of measured values.

Actual parameters settings of each relay can be displayed by pressing of „▲“ key. To change any parameter, press the „Set“ key, enter password (default 0000) and set required value. Then click on „Set“ and pressing „Esc“ key exit setup mode. To change the password and to set all other parameters (acoustic alarm, limits of CO<sub>2</sub> indication, computed value selection etc.) is used **Extended setting mode**.

For network device connection it is necessary to know new suitable IP address (you can get it automatically from DHCP server or from your network administrator) and to have *TSensor* software installed. After you connect Ethernet cable, power adapter or PoE splitter, you run *TSensor* program, set the new IP address, configure the device in accordance with your requirements and finally store the settings. The default IP address of each device is preset to **192.168.1.213**.

After switching the device starts internal test. During this time (about 20 s) LCD display shows **----** instead of CO<sub>2</sub> concentration value.

Devices don't require special maintenance. We recommend you periodical calibration for validation of measurement accuracy.

## ERROR STATES

Device continuously checks its state during operation and if an error appears, it is displayed relevant code: **Err 1** – measured value (except of CO<sub>2</sub> concentration) or calculated value is over the upper limit, **Err 2** – measured or calculated value is below the lower limit or concentration CO<sub>2</sub> measurement error occurred, **Err 0**, **Err 3** and **Err 4** – it is a serious error, please contact distributor of the device, **Err 5**, **Err 6** - there is problem with assigned value to output relay, **Err 9** – inserted password is not valid.

## SAFETY INSTRUCTIONS



- Humidity and temperature sensors of the regulator cannot be operate and store without a filter cap.
- Temperature and humidity sensors have not to be exposed to direct contact with water and other liquids.
- It is not recommended to use the humidity regulators for long time under condensation conditions.
- Take care when unscrewing the filter cap as the sensor element could be damaged.
- The regulator must be turned on for at least 24 hours in order to start the automatic calibration of the CO<sub>2</sub> sensor.
- Use only the power adapter according to technical specifications and approved according to relevant standards.
- Don't connect or disconnect devices while power supply voltage is on.
- Installation, electrical connection and commissioning should be performed by qualified personnel only.
- Devices contain electronic components, it needs to liquidate them according to currently valid conditions.

## Technical specifications

Device type	AT-VLS-104DE	AT-VLS-101DE	AT-VLS-102DE	AT-VLS-106DE
Supply voltage / power consumption during normal operation / max. power consumption (for 50 ms with 15 s period)	9 - 30Vdc / 1W / 4W	9 - 30Vdc / 1W / 4W	9 to 30Vdc / 1W / 4W	9 to 30Vdc / 1W / 4W
Relay outputs - max. switching voltage / max. switching current / max switching power	50V / 2A / 60VA	50V / 2A / 60VA	50V / 2A / 60VA	50V / 2A / 60VA
Temperature measuring range	—	—	-30 to +80 °C	-30 to +105 °C
Accuracy of temperature measurement	—	—	± 0.4 °C	± 0.4 °C
Relative humidity (RH) measuring range *	—	—	0 to 100 %RH	0 to 100 %RH
Accuracy of humidity measurement from 5 to 95 %RH at 23 °C	—	—	± 2.5 %RH	± 2.5 %RH
CO <sub>2</sub> concentration measuring range **	0 to 10 000 ppm	0 to 2000 ppm	0 to 2000 ppm	0 to 10 000 ppm
Accuracy of CO <sub>2</sub> concentration measurement at 25 °C and 1013 hPa	± (100ppm+5% of measured value)	± (50ppm+2% of measuring value)	± (50ppm+2% of measuring value)	± (100ppm+5% of measured value)
Other calculated humidity variables - dew point temperature, absolute humidity, specific humidity, .....	—	—	yes	yes
Recommended calibration interval - relative humidity / temperature / CO <sub>2</sub>	— / — / 5 years	— / — / 5 years	1 year / 2 years / 5 years	1 year / 2 years / 5 years
Protection class - case with electronics / measuring end of stem / CO <sub>2</sub> probe / RH+T probe	IP30 / — / IP65 / —	IP30 / — / — / —	IP30 / IP40 / — / —	IP30 / — / IP65 / IP40
Temperature operating range of the case with electronics ***	-30 to +80 °C	-30 to +60 °C	-30 to +60 °C	-30 to +80 °C
Temperature operating range of the measuring end of stem	—	—	—	—
Temperature operating range of the CO <sub>2</sub> external probe	-40 to +60 °C	—	—	-40 to +60 °C
Temperature operating range of the RH+T external probe	—	—	—	-30 to +105 °C
Humidity operating range (no condensation)	0 to 100%RH	5 to 95%RH	5 to 95%RH	0 to 100%RH
Atmospheric pressure operating range	850 to 1100 hPa	850 to 1100 hPa	850 to 1100 hPa	850 to 1100 hPa
Mounting position	any position	any position	any position	any position
Storage temperature range (5 to 95%RH, no condensation, atmospheric pressure 700 to 1100 hPa)	-40 to +60 °C	-40 to +60 °C	-40 to +60 °C	-40 to +60 °C
Electromagnetic compatibility according to	EN 61326-1 EN 55011	EN 61326-1 EN 55011	EN 61326-1 EN 55011	EN 61326-1 EN 55011
Weight of the device without RS232 communication cable (weight of the cable is 70g)	420 (450, 510) g	330 g	350 g	500 (570, 710) g
Dimensions [mm]	136 117 45 148	104 82 104	75 12.4 18	150 12.4 18 18.5

## Device connection procedure

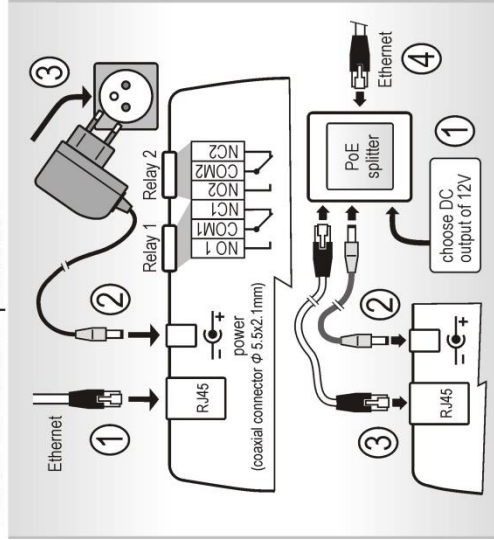

\* The relative humidity measuring range is limited at temperatures above 65°C, see manuals for devices.

\*\* LED indication (preset by manufacturer): **green** (0 to 1000 ppm), **yellow** (1000 to 1200 ppm), **red** (1200 to 2000/10000 ppm).

\*\*\* It is recommended to switch off the LCD display at ambient temperature above 70 °C.